

FUZZY 080.1030.25.1/DALI

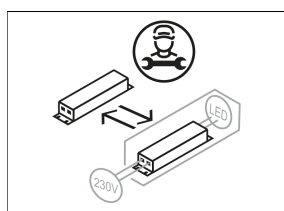

Colori	Articolo n.	EAN
nero	649070	4043544567420
argento	649071	4043544567437
bianco	649072	4043544567444

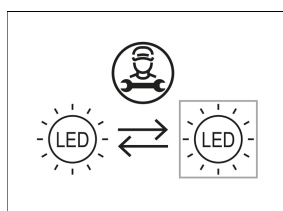
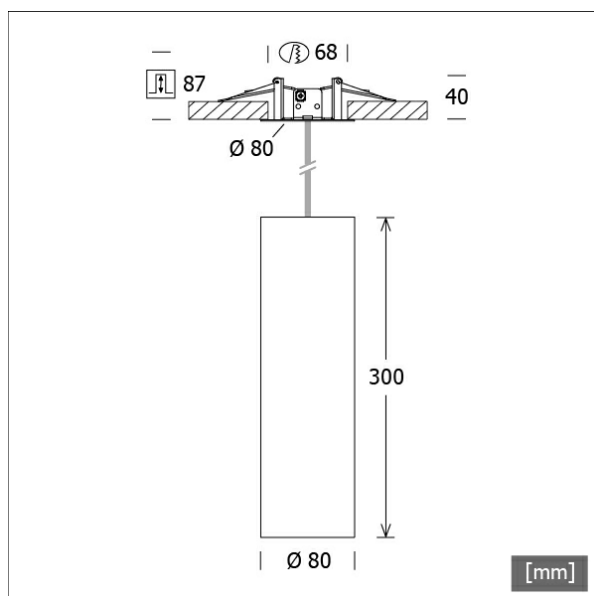

Descrizione

- lampada a sospensione cilindrica in filigrana
- lampada comprensiva di anello a effetto luce trasparente standard
- lampada espandibile con diversi anelli a effetto luce e vetri decorativi
- elevata facilità di manutenzione
- assenza di radiazioni termiche e UV
- gestione termica con raffreddamento passivo
- riflettore a specchio in alluminio con curva fotometrica simmetrica precisa per un'alta resa luminosa e il controllo ottimale dell'abbagliamento
- cilindro in alluminio
- sospensione a cavo trasparente (lunghezza: 1500 mm)
- scatola di alimentazione a soffitto in alluminio per montaggio senza attrezzi con molle di serraggio rapido (regolazione automatica dello spessore del soffitto)
- morsetto a 5 poli
- alimentatore (convertitore LED DALI, dimmerabile) integrato nella lampada

Opzioni standard



Opzioni speciali



Dati illuminotecnici / Norme

Lampade	LED Spot / CRI 80 / 3000 K
EPREL fonti luminose	988880
Durata	L90 B50 50.000 h L80 B50 100.000 h L80 B20 50.000 h
Prestazioni sistema	15.0 W
Flusso luminoso apparecchio	max. 1370 lm
Efficienza sistema	85.33 lm/W
Efficienza del modulo	134.38 lm/W
UGR classe	≤28
Zona di fascio luminoso	Medium Flood
Angolo del fascio luminoso	26°
Tensione di alimentazione	220 - 240 V / 50 - 60 Hz
Classe di protezione	I
Tipo di protezione	IP20

Dimensioni / pesi

Diametro esterno	80 mm
Altezza	300 mm
Dimensione foro (Ø)	68 mm
Spessore soffitto	12.0 - 22.0 mm
Profondità di incasso	87 mm
Peso netto	1.59 kg
Peso lordo	1.68 kg

FUZZY 080.1030.25.1/DALI

Fuzzy (FLIRZ 100.24, 1xLED 15W 830/3000K 1280lm 25 °)

C0/C180 cd / 1000 lm

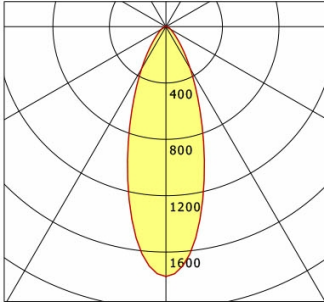

	C0	C90	C180	C270
0°	1774	1774	1774	1774
15°	1052	1052	1052	1052
30°	345	345	345	345
45°	99	99	99	99
60°	39	39	39	39
75°	17	17	17	17
90°	0	0	0	0
cd / 1000 lm				

Offset [m] Cone width [m] Illuminance [lx]

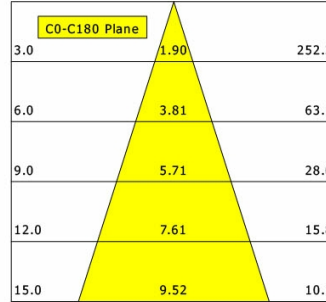

η	LED
Efficiency	85 lm/W
Direct/Indirect	↓ 100% / ↑ 0%
System Power	15 W
UGR	X=4H, Y=8H
Reflection factors	70/50/20
UGR C0/C180	26.6
UGR C90/C270	26.6
CIE Flux Codes	84 95 99 100 100
Ra/CRI	>80

LTS

Fuzzy (FLIRZ 100.25, 1xLED 15W 830/3000K 1320lm 25 °)

C0/C180 cd / 1000 lm

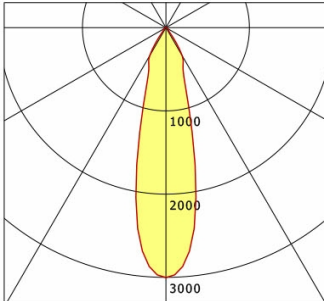

	C0	C90	C180	C270
0°	3002	3002	3002	3002
15°	1136	1136	1136	1136
30°	389	389	389	389
45°	44	44	44	44
60°	23	23	23	23
75°	8	8	8	8
90°	0	0	0	0
cd / 1000 lm				

Offset [m] Cone width [m] Illuminance [lx]

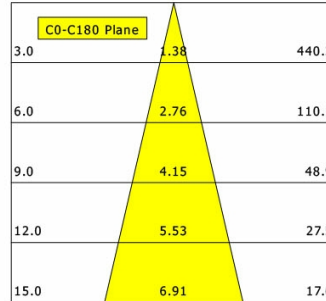

η	LED
Efficiency	88 lm/W
Direct/Indirect	↓ 100% / ↑ 0%
System Power	15 W
UGR	X=4H, Y=8H
Reflection factors	70/50/20
UGR C0/C180	22.8
UGR C90/C270	22.8
CIE Flux Codes	91 97 99 100 100
Ra/CRI	>80

LTS

Fuzzy (FLIRZ 100.05, 1xLED 15W 830/3000K 1370lm 25 °)

C0/C180 cd / 1000 lm

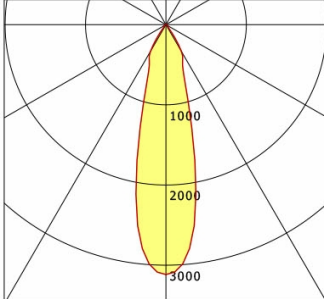

	C0	C90	C180	C270
0°	3116	3116	3116	3116
15°	1159	1159	1159	1159
30°	385	385	385	385
45°	34	34	34	34
60°	21	21	21	21
75°	9	9	9	9
90°	0	0	0	0
cd / 1000 lm				

Offset [m] Cone width [m] Illuminance [lx]

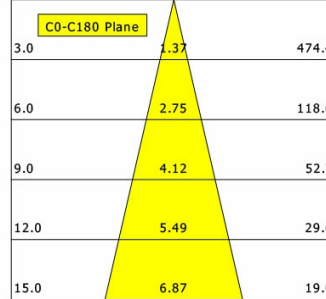

η	LED
Efficiency	92 lm/W
Direct/Indirect	↓ 100% / ↑ 0%
System Power	15 W
UGR	X=4H, Y=8H
Reflection factors	70/50/20
UGR C0/C180	23.0
UGR C90/C270	23.0
CIE Flux Codes	93 97 99 100 100
Ra/CRI	>80

LTS

FUZZY 080.1030.25.1/DALI

Accessori



FLIRZ 100.04
Anello a effetto luce opale



FLIRZ 100.05
Anello a effetto luce trasparente

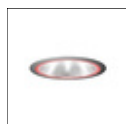

FLIRZ 100.16
Anello a effetto luce rosso traslucido



FLIRZ 100.17
Anello a effetto luce giallo traslucido



FLIRZ 100.18
Anello a effetto luce blu traslucido



FLIRZ 100.19
Anello a effetto luce arancione traslucido

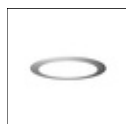

FLIRZ 100.24
Vetro decorativo opale



FLIRZ 100.25
Vetro decorativo trasparente



ZB-OR DONGLE
Organic Response Kit dongle IR



ZB-OR GATEWAY
Organic Response serie a cascata gateway IoT



ZB-OR-P SENSOR/3000
Sensore Organic Response per montaggio a sospensione



ZB-OR-R SENSOR
sensore Organic Response per montaggio a incasso