

FLIR 200.2027.50

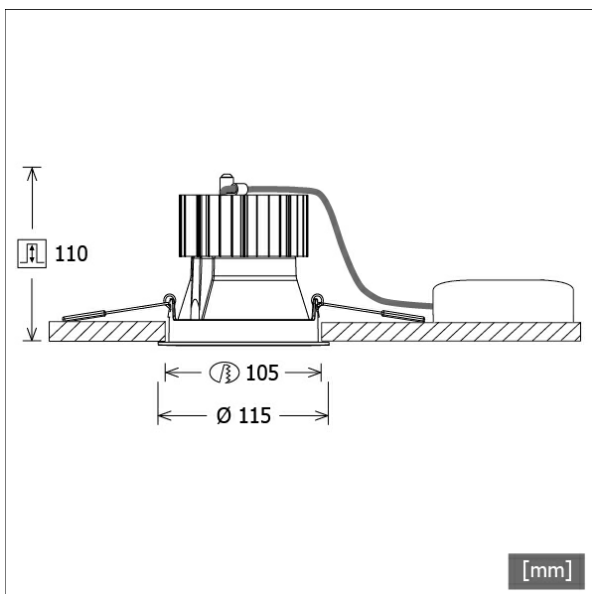

Farbe	Artikelnummer	EAN
schwarz	636613	4043544391957
silber	636614	4043544391964
weiß	636615	4043544391971



Beschreibung

- Einbaustrahler mit optischen Designvarianten und breitem Anwendungsspektrum
- Lichtkopf 20° schwenkbar
- hohe Wartungsfreundlichkeit
- keine UV- und Wärmestrahlung
- Wärmemanagement mit Passivkühlung (Kühlkörper aus Aluminium)
- High-Performance Spiegelreflektor aus Aluminium mit präziser symmetrischer Abstrahlcharakteristik für maximale Lichtausbeute und optimale Entblendung
- Front-/Einbauring aus Zinkdruckguss mit Lichteffektring klar (weitere Dekor-/Lichteffektringe und Dekogläser sind als Option erhältlich)
- werkzeugloser Deckeneinbau mit Schnellspannfedern (automatische Anpassung der Deckenstärke)
- Leuchte und Betriebsgerät über Kabel (Länge: 500 mm) fest verbunden, Betriebsgerät fertig für Netzanschluss
- Betriebsgerät (LED-Konverter) inklusive (Platzierung extern)

Standardoptionen



Sonderoptionen



Lichttechnik / Normen

Leuchtmittel	LED Spot / CRI 80 / 2700 K
EPREL Lichtquellen	848120
Lebensdauer	L90 B50 50.000 h L80 B50 100.000 h L80 B20 50.000 h
Systemleistung	27,0 W
Leuchten-Lichtstrom	max. 2740 lm
Systemeffizienz	101,48 lm/W
Moduleffizienz	127,18 lm/W
UGR Klasse	≤28
Abstrahlbereich	Wide Flood
Abstrahlwinkel	51°
Versorgungsspannung	220 - 240 V / 50 - 60 Hz
Schutzklasse	II
Schutzart	IP20

Abmessungen / Gewichte

Außendurchmesser	115 mm
Höhe	112 mm
Ausschnittsmaß (Ø)	105 mm
Deckenstärke	1,0 - 25,0 mm
Einbautiefe	110 mm
Nettogewicht	0,87 kg
Bruttogewicht	0,95 kg

FLIR 200.2027.50

FLIR 200.2027.50

Flixx 200 Round (FLIRZ 200.05, 1xLED 27W 827/2700K 2740lm 51°)

— C0/C180 cd / 1000 lm

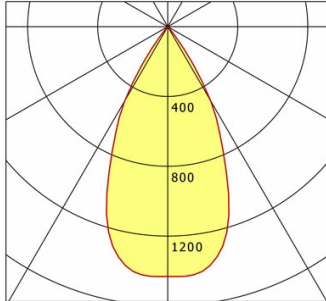

	C0	C90	C180	C270
0°	1431	1431	1431	1431
15°	1264	1264	1264	1264
30°	492	492	492	492
45°	17	17	17	17
60°	14	14	14	14
75°	6	6	6	6
90°	0	0	0	0
cd / 1000 lm				

Offset [m] Cone width [m] Illuminance [lx]

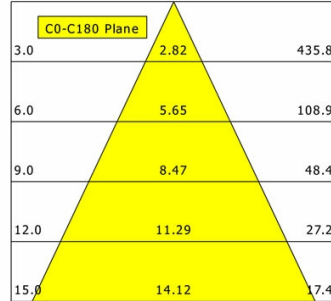

η	LED
Efficiency	102 lm/W
Direct/Indirect	↓ 100% / ↑ 0%
System Power	27 W
UGR	X=4H, Y=8H
Reflection factors	70/50/20
UGR C0/C180	21.2
UGR C90/C270	21.2
CIE Flux Codes	95 98 100 100 100
Ra/CRI	>80

LTS

FLIR 200.2027.50

Flixx 200 Round (FLIRZ 200.25, 1xLED 27W 827/2700K 2660lm 51°)

— C0/C180 cd / 1000 lm

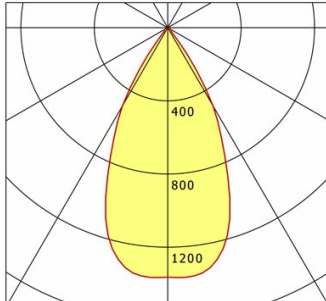

	C0	C90	C180	C270
0°	1364	1364	1364	1364
15°	1216	1216	1216	1216
30°	494	494	494	494
45°	27	27	27	27
60°	17	17	17	17
75°	6	6	6	6
90°	0	0	0	0
cd / 1000 lm				

Offset [m] Cone width [m] Illuminance [lx]

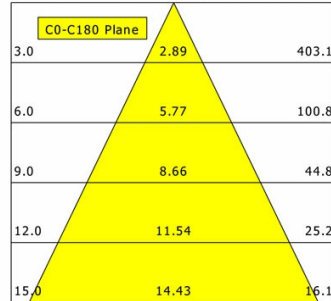

η	LED
Efficiency	99 lm/W
Direct/Indirect	↓ 100% / ↑ 0%
System Power	27 W
UGR	X=4H, Y=8H
Reflection factors	70/50/20
UGR C0/C180	21.5
UGR C90/C270	21.5
CIE Flux Codes	94 98 100 100 100
Ra/CRI	>80

LTS

FLIR 200.2027.50

Flixx 200 Round (FLIRZ 200.24, 1xLED 27W 827/2700K 2580lm 51°)

— C0/C180 cd / 1000 lm

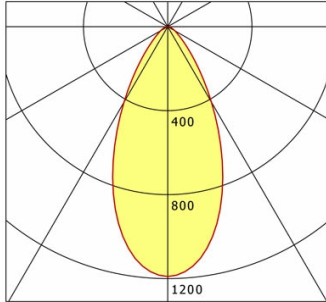

	C0	C90	C180	C270
0°	1190	1190	1190	1190
15°	936	936	936	936
30°	415	415	415	415
45°	116	116	116	116
60°	39	39	39	39
75°	16	16	16	16
90°	0	0	0	0
cd / 1000 lm				

Offset [m] Cone width [m] Illuminance [lx]

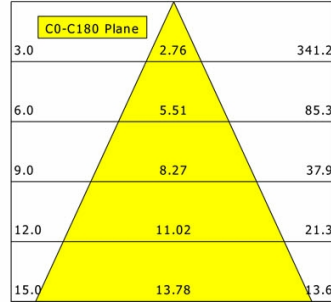

η	LED
Efficiency	96 lm/W
Direct/Indirect	↓ 100% / ↑ 0%
System Power	27 W
UGR	X=4H, Y=8H
Reflection factors	70/50/20
UGR C0/C180	26.2
UGR C90/C270	26.2
CIE Flux Codes	83 95 99 100 100
Ra/CRI	>80

LTS

FLIR 200.2027.50

Zubehör



FLIRZ 200.01
Dekorring schwarz



FLIRZ 200.02
Dekorring silber



FLIRZ 200.03
Dekorring weiß



FLIRZ 200.04
Lichteffektring opal



FLIRZ 200.05
Lichteffektring klar



FLIRZ 200.06
Lichteffektring rot matt



FLIRZ 200.07
Lichteffektring gelb matt



FLIRZ 200.08
Lichteffektring blau matt



FLIRZ 200.16
Lichteffektring rot transluzent



FLIRZ 200.17
Lichteffektring gelb transluzent



FLIRZ 200.18
Lichteffektring blau transluzent

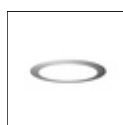

FLIRZ 200.24
Dekoglas opal



FLIRZ 200.25
Dekoglas klar